

Varenummer: 201581M830MTH1
 Beskrivelse: E+G Bolt GN 1582-M8-30-MT-H-1
 Hygiejnisk design

Mål

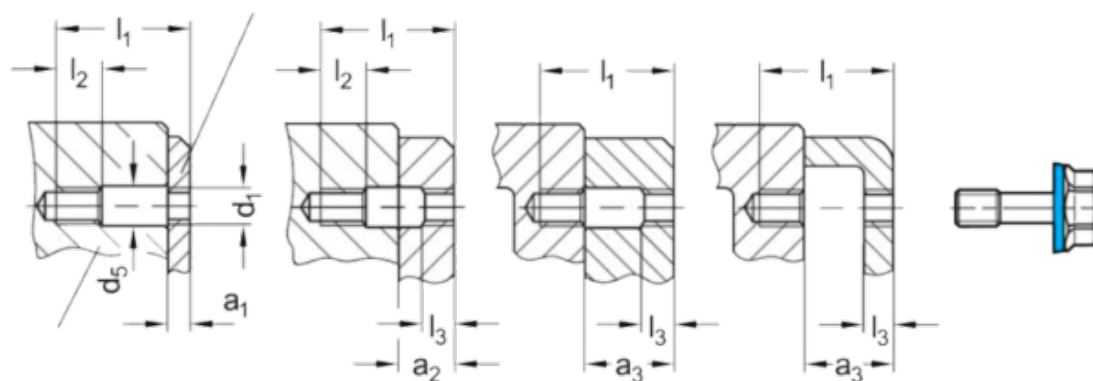
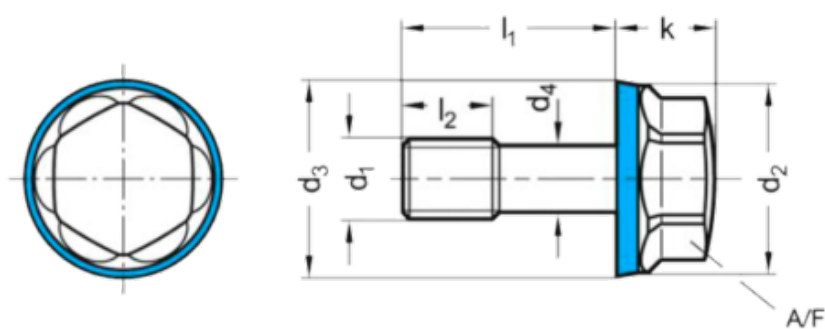

a1	= 4-8	l1	= 30
a2	= 8-16	l2	= 10
a3	= 16-20	l3	= 4
AF	= 13	Vægt	= 18
d3	= 16.8		
d4	-0,2 = -		
d5	= 8.5		
k	= 8.5		